

TITLE

Technical investigation of an inshore accident with a twin crane lift arrangement from two barges.

AUTHOR

Ir. Herm Bussemaker, MSc Naval Architect, Orca Offshore b.v., The Netherlands

KEY WORDS: Alphen aan den Rijn, Julianabrug, Twin crane lift, Barge stability, Crane accident, Lift Stability, Crane tip stiffness

PUBLISHED: 6 July 2016

ABSTRACT

This paper describes a technical accident investigation concerning a bridge lift performed by two land based mobile cranes placed on two barges. During the lift the barges lost stability and fell over onto various houses at the side of the channel. Fortunately no casualties have been reported other than one dog who perished.

This paper describes the post accident technical investigation performed by Orca Offshore and Saetech for the Dutch Safety Board (www.onderzoeksraad.nl).

Conclusion of this investigation is that the direct reason for the failure of the system was a critical stability which caused a sudden large heel which led to overloads on various structures leading to a progressive collapse.

It was found that no mandatory requirement regarding pontoon stability exist for this type of operation. A minimum GMT stability requirement has been used but it appeared that the complexity of the design was underestimated. An important finding of this investigation was the de-stabilising effect of the flexibility of the used cranes which has shown to be an important contributor to this accident.

Main technical lessons learned from the accident investigation were:

- Multiple crane lifts from one or more pontoon(s) are much more complicated to assess with regards to stability than a single crane lift
- A land based mobile crane is not designed for use on a pontoon and should not be used on a pontoon unless the crane manual or the crane manufacturer has given clear usage limits for the crane on a pontoon.
- Land based mobile cranes have low stiffness at the crane tip in horizontal direction which has a large effect on the stability of the pontoon.
- No rules, guidelines or recommendation exists to evaluate the risk of capsizing for using a land based mobile crane on a flat pontoon.
- Standard ship or barge stability requirements are not sufficient to assure a safe lift from a barge

Pre-face

Orca Offshore and Saetec have performed a technical evaluation of the accident on request of the Dutch Safety Board. The objective of the investigation was to evaluate the feasibility of the plan and to identify the root cause of this accident.

The Incident

In Alphen aan de Rijn in the Netherland on August 2015 a new bridge fly of the "Julianabrug" had to be installed on the bridge lands. The bridge fly arrived on a transport barge in a near vertical position. Two telescope type land based mobile cranes operated from two barges had to pick-up the bridge fly, rotate the bridge to horizontal position and move the bridge between the cranes. After this operation the whole assembly had to be relocated to the bridge. One of the barges had to fit between the bridge landings which did put a constraint on the width of that barge.

The two barges with the cranes were moored against the barge with the bridge fly. To pick-up the lift it was required to apply pretension with the crane and to ballast the barges to keep them on even keel. This operation took several hours. After lifting the bridge fly free from the supports, the crane operators started a slow inward move. At that moment the two barges developed a large list and the control over the system was lost which eventually

led to a progressive collapse and a complete fall over of the two cranes.



Figure 1 Situation after the accident (Source OVV)

The precise order of events could be different, but in reality that would not have mattered at all. The analytical assessment has shown that the system was unstable at the moment the lift was completely hanging free. This means that whatever action was taken the system would have collapsed anyway.

Assessment of the lift

After the incident the investigation board and the authorities have measured the condition of the barges in terms of floating position and filling of the ballast tanks. The cranes have also been measured in to determine the radius and length of the boom. Also the computer control systems have been secured and processed.

Based on these measurements and on various pictures and video's taken before and during the incident it was possible to determine the properties of the system. The engineering drawings and calculations have also been included in the assessment.

Barge Stability numbers

With this information the stability of the two barges has been back calculated using the standard method for ships and barges as also used for the preparation of this lift. This approach calculates the stabilising moment of each barge separately as function of a heel angle and includes the weight and CoG of all items on the barge, the water in the ballast tanks, the free surface effect of the partly filled tanks, and the crane load as weight acting in the tip of the crane.

The stability at the equilibrium position has been evaluated using the GMt value which represents the transfers initial metacentric height of the barge. The GMt should normally be positive with an adequate margin for inaccuracies. Figure 2 shows a typical stability curve of a barge or ship. This plot represents the righting capacity of the barge as function of the heel angle. The initial GMt value is also indicated in this graph. A GMt value of zero or less represent an unstable condition of the barge which will lead to a large list towards a new equilibrium position with a positive GMt value. Figure 3 presents an example stability curve representing a negative GMt value at the evenkeel (heel=0°) situation of the ship. The stability curve shows a new equilibrium position at a heel angle of 30°.

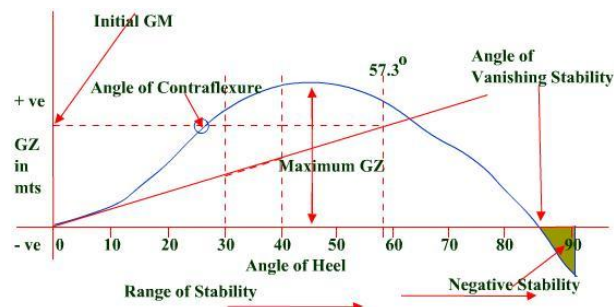

Figure 2 Example Stability curve (Source: www.shipinspection.eu)

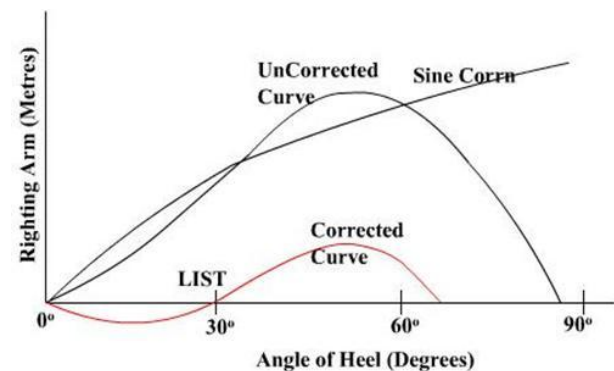

Figure 3 Example Stability curve (Source: www.shipinspection.eu)

For this accident the initial GMt at the floating position seconds before the start of the incident has been calculated.

Table 1 presents the results of the post accident stability analysis expressed in terms of GMt.

| ID | Stability number GMt | | Remark |
|----|----------------------|---------|---------------------------------------|
| | Barge 1 | Barge 2 | |
| 01 | 0.82 m | 2.22 m | Post accident standard calculated GMt |

Table 1 – Barge Stability as determined and based on standard approach

Before the accident various arrangements have been checked. The final arrangement has actually not been checked due to miscommunication. The barge owner used a minimum GMt requirement of 2.5 m to check the suitability of the barge. The final situation did not comply with the minimum requirement of the barge owner, but due to miscommunication this was not noted.

After the incident various parties have calculated the stability of the barges and all analysis resulted in small but positive GMt values of the two barges. The GMt values are low which means that an operation like this will be very difficult and very risky. But the GMt values are positive so the system should be stable and instability would not be the direct cause of this accident.

Detailed assessment

The calculated direct single barge stability showed that the stability was low but as such is still not the direct cause of the accident. Based on this a more detailed assessment has been initiated which concentrated on the methods to calculate the stability and to determine which loads could have initiated the observed list of the barges. The following subjects have been further reviewed:

- Assessment of the Calculation Method
 - Accuracy of the used input data for the stability analysis
 - Validity of the assumption behind the stability assessment method
 - Effect of twin crane arrangement on stability
- Assessment of heel sensitivity
 - Effect of uncontrolled external loads
 - Effect of controlled loads (Ballast actions, crane actions, mooring lines)

Assessment of calculation method

A short error sensitivity assessment has been done to show the margin of error the GM calculation could have. Major uncertainties in the system would be;

- Crane settings
- Lift load
- Ballast condition
- Barge Floating condition
- Barge and deckload weight and CoG (Centre of Gravity)
- Crane weight and CoG

Table 2 presents the absolute error in the GMt calculation of both barges based on an realistic assumed accuracy of the input parameter and 95% probability of exceedance limit.

| ID | Stability number GMt | | Remark |
|------|----------------------|---------|---------------------------------------|
| | Barge 1 | Barge 2 | |
| 01 | 0.82 m | 2.22 m | Post accident standard calculated GMt |
| 02 | ±0.46m | ±0.53 m | Error estimate 95% probability |
| 03 | -0.03 m | -0.05 m | Mean of error estimate |
| Max | 1.25 m | 2.70 m | Highest GMt estimate |
| Best | 0.79 m | 2.17 m | Best GMt estimate |
| Min | 0.33 m | 1.64 m | Lowest GMt estimate |

Table 2 – Summary 1 of GMt calculation

The validity of the used methods to calculate the stability of two barges with two cranes connected through the lift load has been reviewed. The main assumptions behind the calculations are:

1. The twin lift arrangement has no effect on the stability of the separate barges
2. The vertical centre of gravity of the lift load acts in crane tip.
3. The system is rigid and will not deform.

Add 1) The barges are connected to each other through the crane tips, the lift rigging and the lift load. The effect this could have on the single barge stability cannot be ignored.

Add 2) This assumption is only valid for a single crane lift. A twin crane lift can show a shift of this point below or even above the crane tip due to geometrical effect in the rigging.

Add 3) This assumption is normally valid for marine cranes as these are designed to accommodate a significant side load on the crane tip which results in a stiff and strong crane boom. Land based cranes, and especially mobile telescopic cranes are not designed for large side loads acting on the crane boom, which makes the stiffness of the crane tip in horizontal direction a lot lower.

In the next sections the above three assumptions will be further evaluated.

Effect of Crane stiffness

The general consensus to calculate stability of a crane barge combination is to assume that the lift load acts in the upper connection point of the lift arrangement generally referred to as the crane tip. This assumption is valid if the crane is infinitely stiff in all directions. Marine and offshore cranes are designed to accommodate a large side load which results in relative large stiffness in the side direction. Land based cranes are in general not designed for large side load which results in a lot lower horizontal stiffness of the crane.



Figure 4 Example crane bending (Source: www.Craneblogger.com)

It has been found that the assumption that the lift load acts in the upper crane block is not valid if the crane is flexible in horizontal direction. The lift load actually acts in a virtual point above the upper block with a vertical offset distance related to the horizontal stiffness of the crane tip.

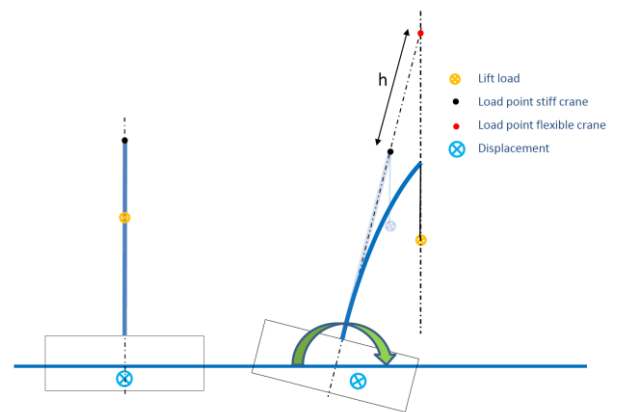

Figure 5 Diagram showing effect of flexible crane

Figure 5 shows a diagram explaining this effect. The diagram shows the deformation of the blue crane boom at a certain barge heel angle. As can be seen, the lift load attachment point has shifted due to the deflection of the boom. The lift load vector now crosses the crane centre line at the red dot which is at h meters above the black dot representing the lift load attachment point for an infinite stiff crane.

A simple formula has been derived which relates the vertical offset of the virtual lift attachment point from the crane tip to the crane tip stiffness as follows:

$$h = HL/k$$

with: h = vertical shift of centre of load (m)
 HL = Hookload (kN)
 k = Crane tip stiffness (kN/m)

The stiffness of one of the telescopic mobile cranes has been calculated by the manufacturer and made available for this investigation. Based in this number the vertical shift for the subject lift showed a vertical shift of the lift attachment point of 12 meter while the height above the barge deck of the crane tip was around 36 m. This resulted in significant GMt reduction. Table 3 presents the calculated GMt reduction for both barges and a summary of the GMt.

| ID | Stability number GMt | | Remark |
|------|----------------------|---------|--|
| | Barge 1 | Barge 2 | |
| 01 | 0.82 m | 2.22 m | Post accident standard calculated GMt |
| 02 | ±0.46m | ±0.53 m | Error estimate 95% probability |
| 03 | -0.03 m | -0.05 m | Mean of error estimate |
| 04 | -0.83 m | -1.01 m | GMt reduction due to crane flexibility |
| Max | 0.45 m | 1.69 m | Highest GMt estimate |
| Best | -0.04 m | 1.16 m | Best GMt estimate |
| Min | -0.50 m | 0.63 m | Lowest GMt estimate |

Table 3 – Summary 2 of GMt calculation

Twin crane lift stability effects

Using two cranes from one or more barges can have an effect on the stability of the barge(s). The hookload division between the two cranes can change as function of the heel angle of the barge and tilt of the load. With a single crane lift this does not occur. This change of hookload relates to the geometry of the lift arrangement and the lift centre of gravity position. Figure 6 shows an example of this effect which actually increases the stability of the barge. The heeled barge on the right of the diagram shows that the hookload has to change to maintain equilibrium of the lift. The hookload of the "down" crane decreases which has a stabilising effect on the barge.

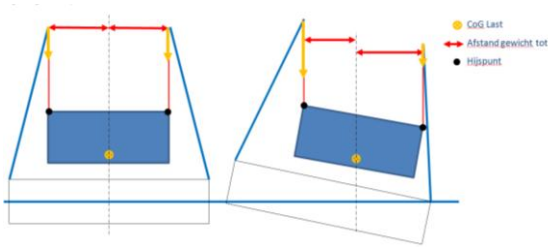

Figure 6 Twin crane effect high lift points

Figure 7 shows an example of this effect which has a negative effect on the stability of the barge. In this case the hookload of the "down" crane increases which has a de-stabilising effect on the barge.

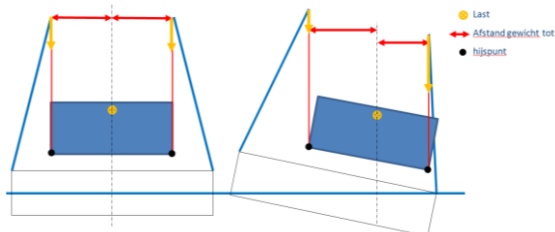

Figure 7 Twin crane effect low lift points

Figure 8 shows an example of this effect with two barges. In this case the hookload of the "down" crane increases which has a de-stabilising effect on both barges.

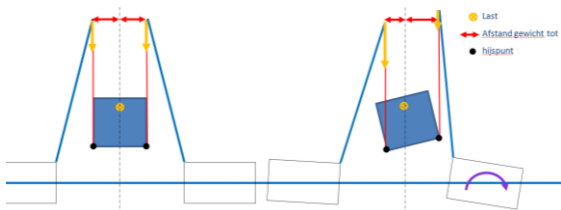

Figure 8 Twin crane effect from two barges

In case the barges are moored in any way to each other, a horizontal load at the crane tip can be developed. Figure 9 shows this effect which has a stabilising effect on both barges. It is however a risky situation as the fendering or mooring can suddenly slip or change which could initiate a sudden heel of the barges.

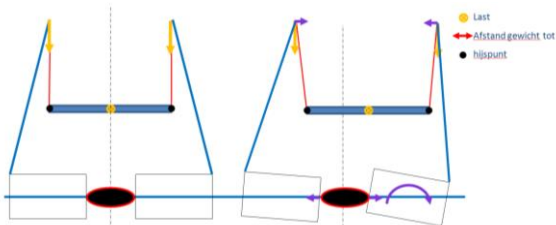

Figure 9 Twin crane effect moored barges

Analysis of Twin lift effects

To calculate stability impact of the twin crane effects by hand is possible but complicated. For this accident investigation a 3D simulation model has been build using the marine simulation

software MOSES from Bentley systems. With this model it is possible to accurately calculate the mentioned twin crane effects.

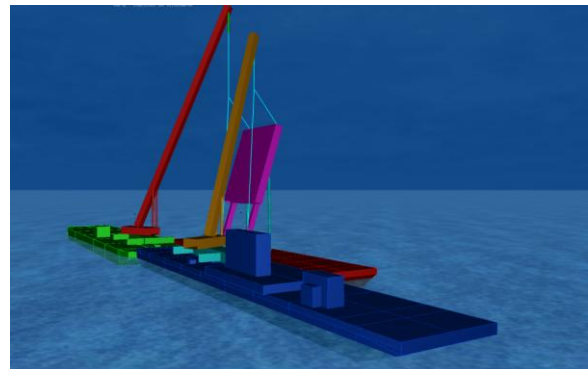

Figure 10 MOSES simulation model for twin lift effects

Figure 10 shows the model used for this analysis. The simulation based on the properties of the subject lift showed that in this case the twin crane stability effect was limited.

Table 4 shows the results of the twin crane effect and the total calculated GMt of the lift.

| ID | Stability number GMt | | Remark |
|------|----------------------|---------|--|
| | Barge 1 | Barge 2 | |
| 01 | 0.82 m | 2.22 m | Post accident standard calculated GMt |
| 02 | ±0.46m | ±0.53 m | Error estimate 95% probability |
| 03 | -0.03 m | -0.05 m | Mean of error estimate |
| 04 | -0.83 m | -1.01 m | GMt reduction due to crane flexibility |
| 05 | -0.02 m | -0.04 m | Twin crane effect |
| Max | 0.40 m | 1.65 m | Highest GMt estimate |
| Best | -0.06 m | 1.12 m | Best GMt estimate |
| Min | -0.52 m | 0.59 m | Lowest GMt estimate |

Table 4 – Final results of GMt calculation

The calculated stability of both barges is very low and barge 1 is even below zero indicating stability problems which will lead to a sudden large heel. The video made of the incident showed that barge 1 indeed initiated the collapse and dragged barge 2 along.

If it can be shown that the highest found GMt value is also not adequate to keep control of the lift it can be concluded that this low stability is indeed the root cause of the incident.

This will be done by assessing the heel sensitivity of the system for existing externally applied loads which could lead to a heeling reaction of the barges.

Assessment of heel sensitivity

The sensitivity of a lift system for external heeling effects is a good measure to evaluate the safety and controllability of the operation. The following external effects can be considered:

- Wind Loads
- Offset loads
- Ballast loads
- Crane actions

The lifted load had a large wind area which was situated perpendicular to the wind direction. Data from the weather institute revealed a wind velocity of 7 m/s one hour mean and 11 m/s 3 second gusts, which represents a BF 4 wind condition.

Offset loads are generated due to a misalignment of the lift. At lift off the offset loads are released which can generate a sudden overturning load on the crane tip.

Ballast water is used to compensate the lift load and to keep the barge on even keel. In this case ballasting was a very slow process which could not initiate a sudden heel of the barges and therefore not further included in this assessment.

Crane actions are described in the case of a telescopic crane the load is moved by hoisting (H), slewing (SI), luffing (Lu) and telescoping (Te), see Figure 11.

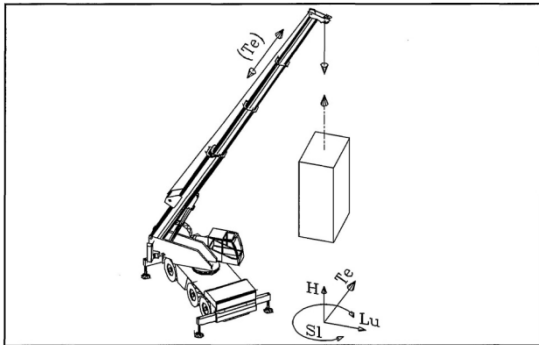

Figure 11 Definition of crane movements (Source: BS EN 13000:2004)

The effect on the barge heel using the calculated GMt values has been calculated and reported in Table 5.

| Effect | Barge static heel | |
|-------------------------------------|-------------------|---------|
| | Barge 1 | Barge 2 |
| Used GMt value | 0.40 m | 1.12 m |
| Wind load increase due to wind Gust | 4.4° | 1.6° |
| Full wind force | 7.9° | 3.0° |
| Misalignment Offset 0.1 m | 1.3° | 0.5° |
| Load move by crane 0.2 m | 2.7° | 1.0° |

Table 5 Heel effect of various external loads

The above table reports the static heel which represent the situation after reaching the new equilibrium and when the motions of the load stopped. But as these loads can rapidly appear, the system will react in a dynamic way which will initiate an overshoot that increase the maximum heel to double the static heel. For instance the wind gust dynamic heel will amount 8.8° which is twice the heel of 4.4°. This is also valid for the other effects.

The video of the incident showed that the crane boom of the crane on barge 1 collapsed at a barge heel angle of around 12°.

Based on the above analysis it can indeed be concluded that even the highest estimate of the calculated GMt is still not adequate to keep control of the lift. A combination of the above effects could easily generate a dangerous heel of the barge leading to an overload or toppling of the cranes.

Simulation of the incident

With the MOSES computer model it is possible to simulate the first 20 second of the incident using a time domain analysis method. In total eighth different simulations have been performed for a range of GMt values in combination with a wind gust and a crane action.

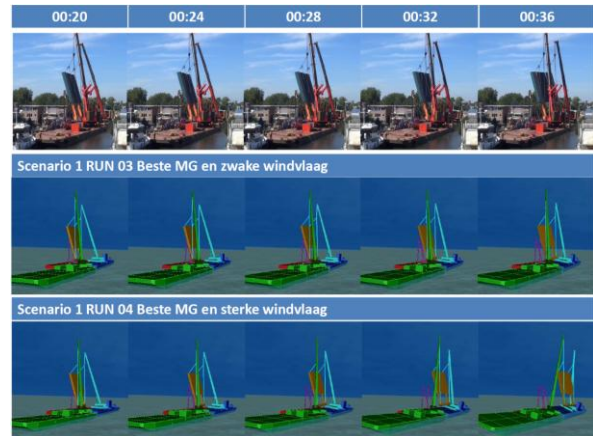

Figure 12 Simulation for wind gust with best estimate GMt values

Figure 12 shows some frames of the video taken from the incident and corresponding frames of the simulation.

The performed simulation showed good correlation with the reality as recorded with the video, also confirming the low stability as root cause of the incident.

Stability requirements

The barges always need to comply with the class or national stability requirements. In this case these requirements were not complied with, but even if the stability would have complied with these stability rules, the lift would still have been hazardous. Barge stability rules are not compiled to cover stability during crane lifts from a barge. In general it can be said that a barge which fully complies with all stability requirements can still be too unstable to perform a safe lift.

Specific stability requirements for a barge crane combination used on inland water do not exist. For offshore application there is nowadays a class requirement regarding the minimum stability during a lift based on a dropped lift load and the ability of the vessel to survive that.

A minimum GMt requirement for a safe lift is not easy to define as it relates to the lift arrangement, the ballast system, the environmental conditions, the crane properties and many other effects. Most contractors working with crane vessel use an inhouse developed minimum GMt requirement which is based on experience and a feeling for such operation.

In this case the contractors used an inhouse minimum GMt value, but due to miscommunication this was not maintained. But even if that value was maintained the lift would still have been very hazardous with very little redundancy regarding stability.

Crane utilisation

The cranes have been used up to full utilisation. It is normally recommended to reduce the allowable crane load for use on a barge. The reduction should be advised by the crane manufacturer as it relates to the strength requirements of the crane outside the land tilt and motion limits. On a barge it can be expected that the crane will tilt during the operation which should be accounted for in the allowable hookload curve.

In this case this has not been done. The cranes were fully utilised based on a land based allowable hookload curve.

Conclusions

The incident investigation revealed that the root cause of this accident was the low stability of the barges. The start of the collapse was possibly initiated by a wind gust or a small crane action which led to a large heel reaction of the barge. As the cranes are not strong enough to take a large heel the progressive collapse of the system was inevitable.

The critical stability of the barges was not known during the execution phase of the project. This was partly due to miscommunications between the various involved contractors and

also due to an unknown destabilising effect of the used crane type on the barges.

It is recommended not to use land based cranes on a barge, even at inland waters, without consulting the crane manufacturer regarding the allowable loads.

For critical and complicated lifts using barges and a twin crane arrangement it is recommended not to rely on standard ship stability software but to perform 3D hydrostatic simulations to evaluate the risks of the planned operation.

Disclaimer

The author or Orca Offshore b.v. cannot be held liable for any consequence arising from the content of this white paper. It is the responsibility of the user to check the correctness of the provided advice, recommendations or opinions for any future operation. The information provided has been based on the public information regarding this incident. Opinions and interpretation of the public information and published in this white paper are not part of the accident investigation and do not reflect the opinion or interpretation of the Dutch Safety Board.

References

1. "Hijsongeval Alphen aan de Rijn", Onderzoeksraad voor de veiligheid, juni 2016
2. "Berekenen technische haalbaarheid en kwetsbaarheid", doc.no. 153026.DOC.001.E1, Orca Offshore, 15-06-2016.
3. "Analyse kwaliteit voorbereiding en uitvoering", doc no. REP-1512-002, Saetech, 15-06-2016.
4. "Analyse Technische haalbaarheid", doc no. REP-1512-003 Saetech, 15-06-2016.

Above documents are available for download at www.onderzoeksraad.nl

5. "Technical note on Crane barge stability", doc.no.153026.TN.001, Orca Offshore bv, 06-07-2016

Above document is available for download at www.orca-offshore.com